

**CH-21-1.0-1.3
Thermoelectric Module
(Peltier Module)
Specifications**

	Material Specifications (27 °C hot side temperature)	Material Specifications (50 °C hot side temperature)
Vmax (V)	2.4	2.7
I _{max} (A)	3.6	3.6
Q _{max} (W)	5.2	5.7
DT _{max} (°C)	69	78
Operation/storage temperature	-40 °C to +80 °C	

Module *material* specifications are nominal values based on the hot-side temperature indicated. Thermoelectric material parameter tolerance is +/-10%.

In no case should the module temperature be allowed to exceed its maximum operation/storage temperature.

Please review all product and technical information, *Thermoelectric Module Mounting Procedure*, FAQ's and ordering information posted on our website before purchasing or using this product.

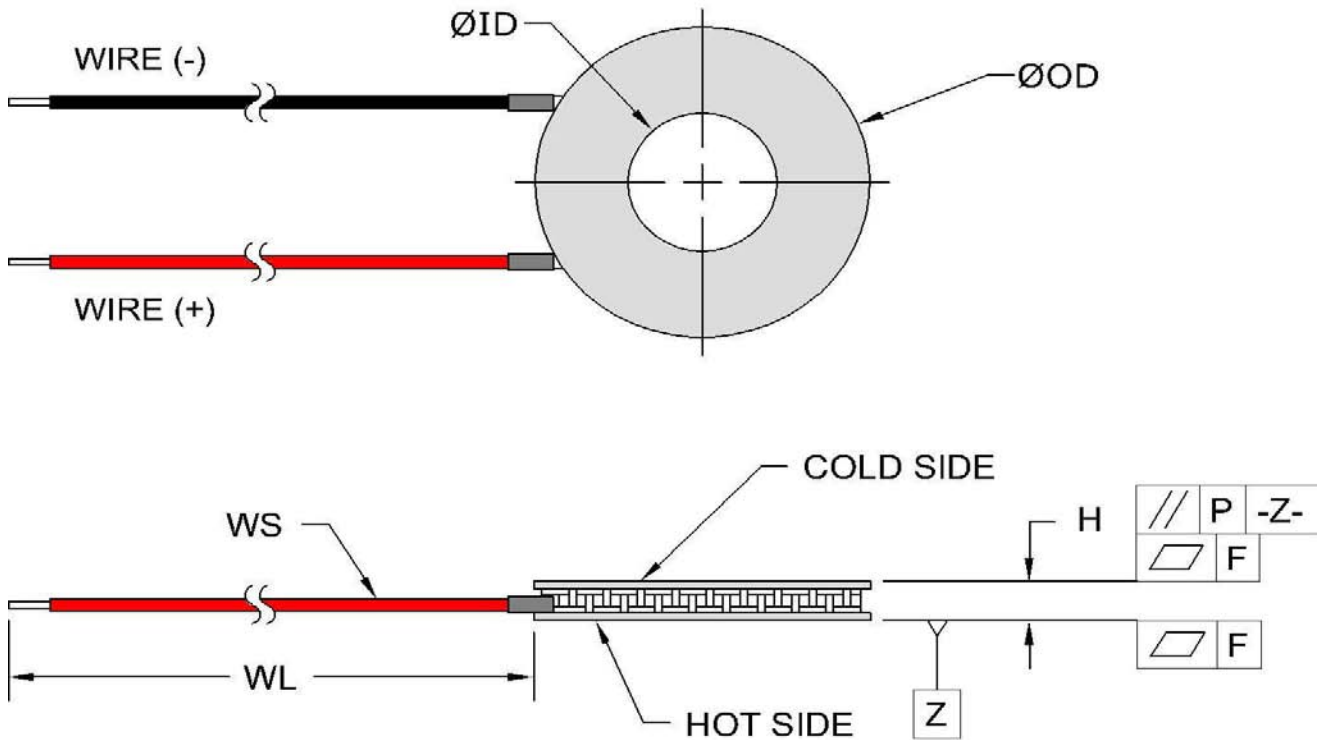

Optional Features and Notes:

Add "P" to part number for sealing module with epoxy potting.

Outer Diameter, OD (mm)	15 +0.5/-0.2
Inner Diameter, ID (mm)	3 +0.2/-0.5
Height, H (mm)	3.6 ±0.05
Flatness, F (mm)	0.02
Parallelism, P (mm)	0.03
Wire Size, WS (mm ²)	0.2
Wire Length, WL (mm)	120

Performance graphs include thermal resistance of substrates.

RoHS Compliant
Directive 202/95/EC



1590 Keane Drive, Traverse City, MI, 49696-8257 USA
PH: 231-929-3966 FAX: 231-929-4163 email: cool@totech.com

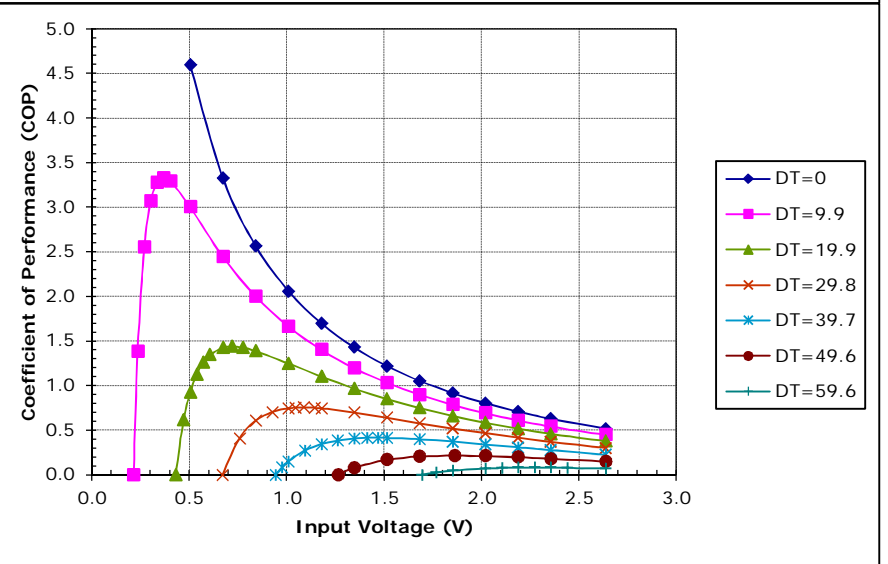
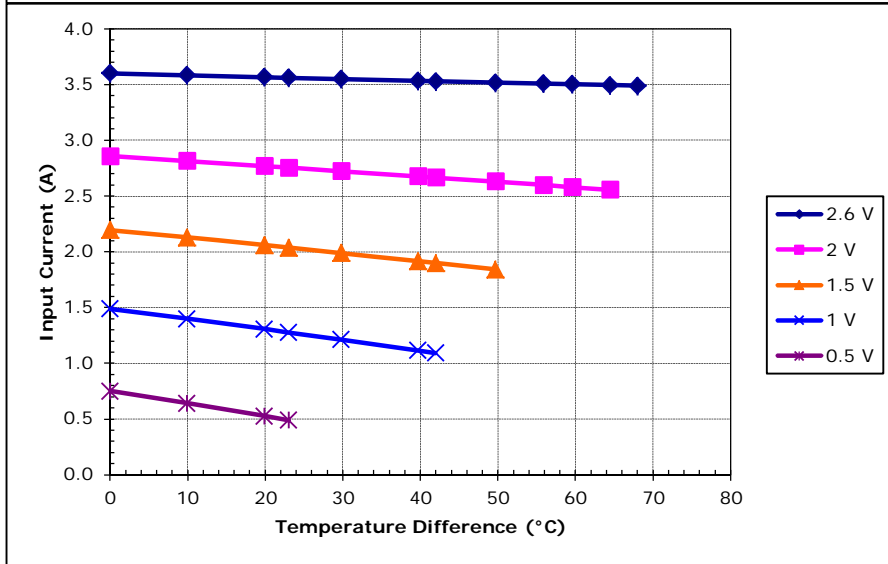
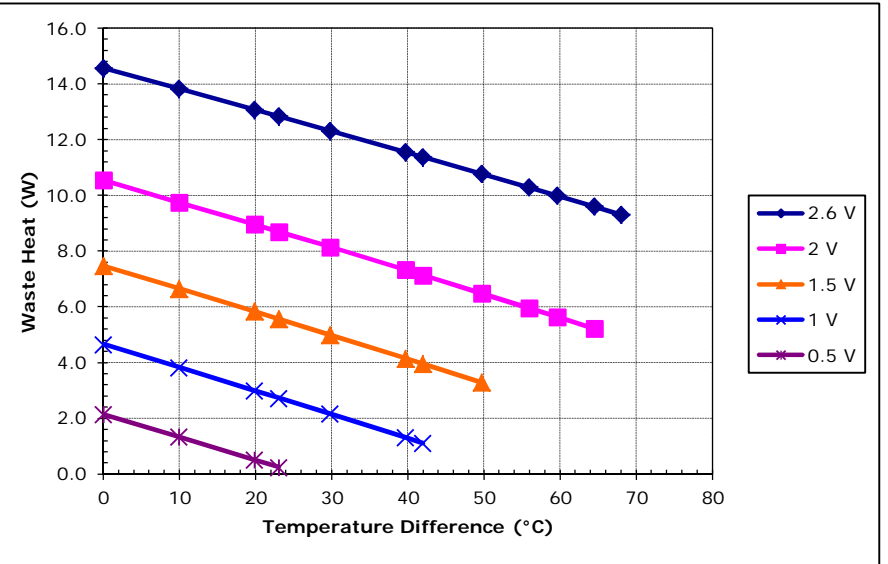
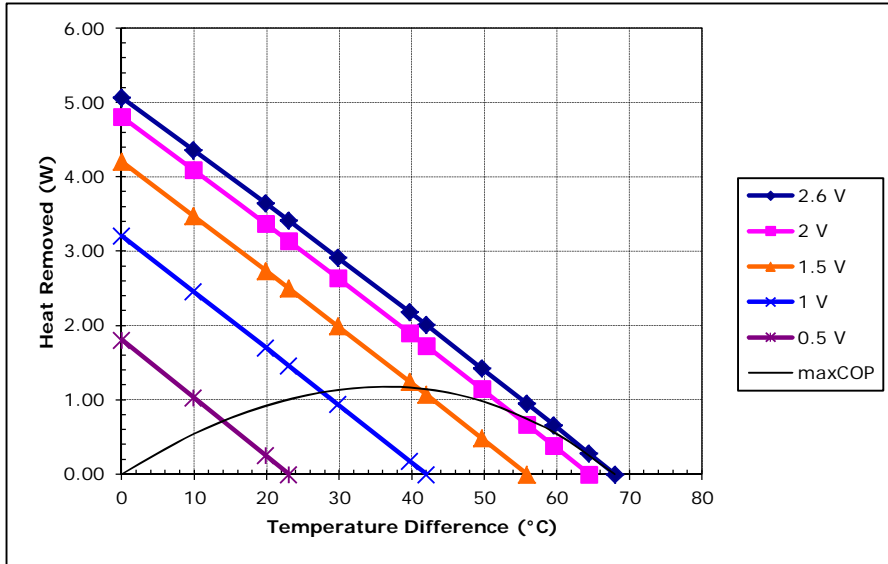

Unpotted CH-21-1.0-1.3 at a hot-side temperature of 30 °C

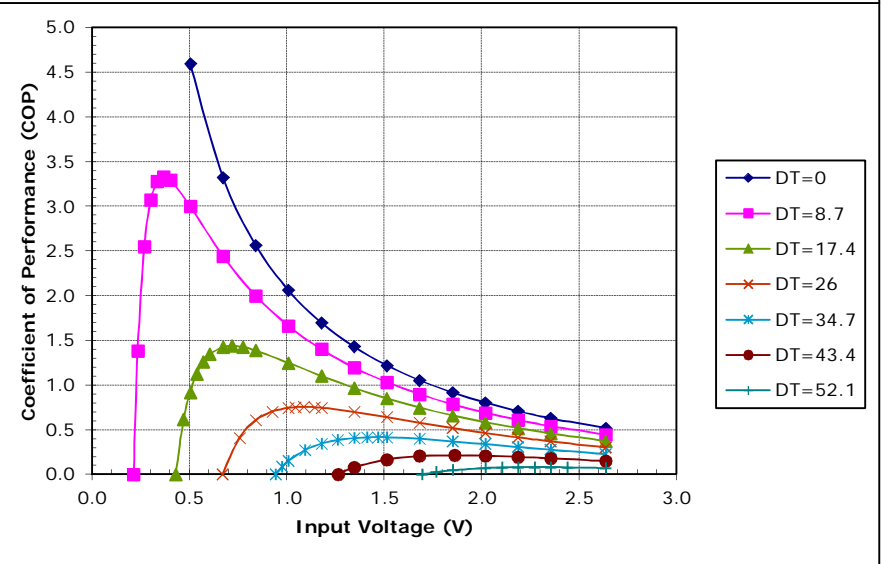
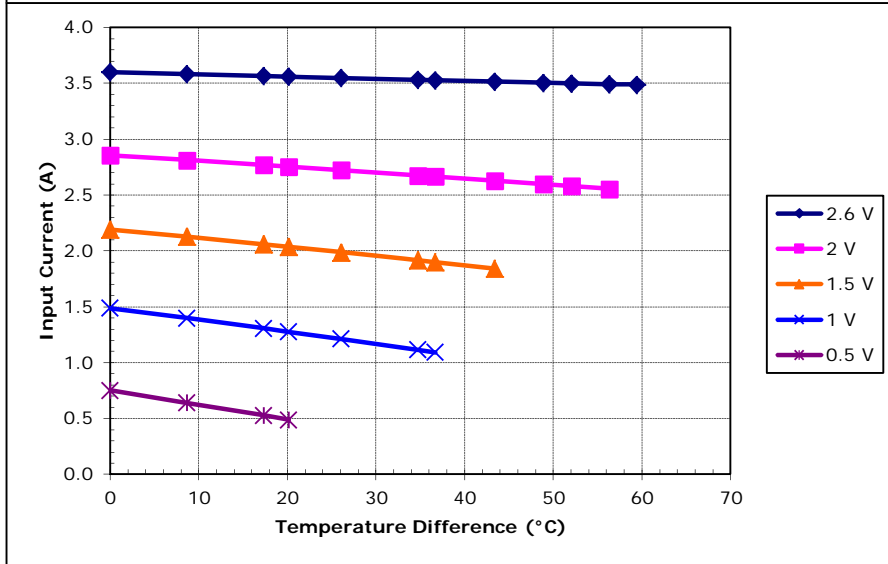
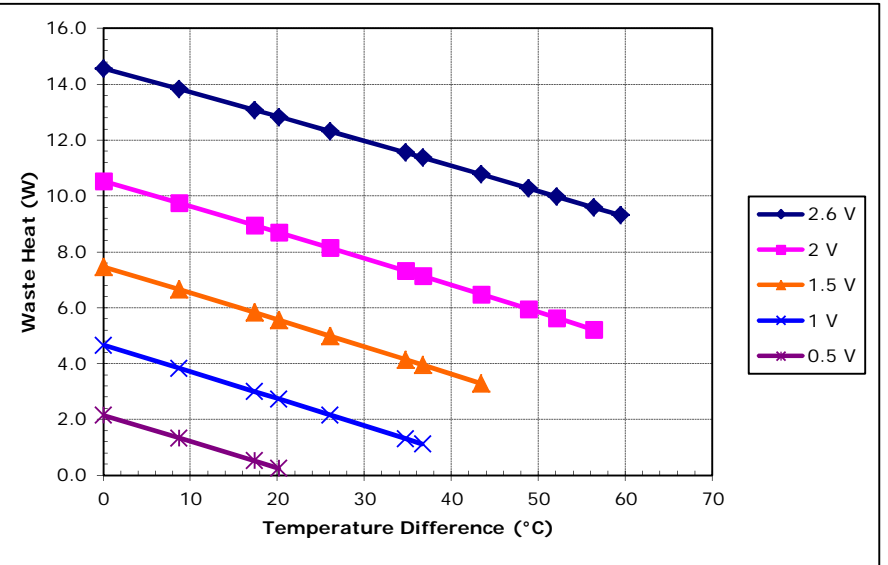
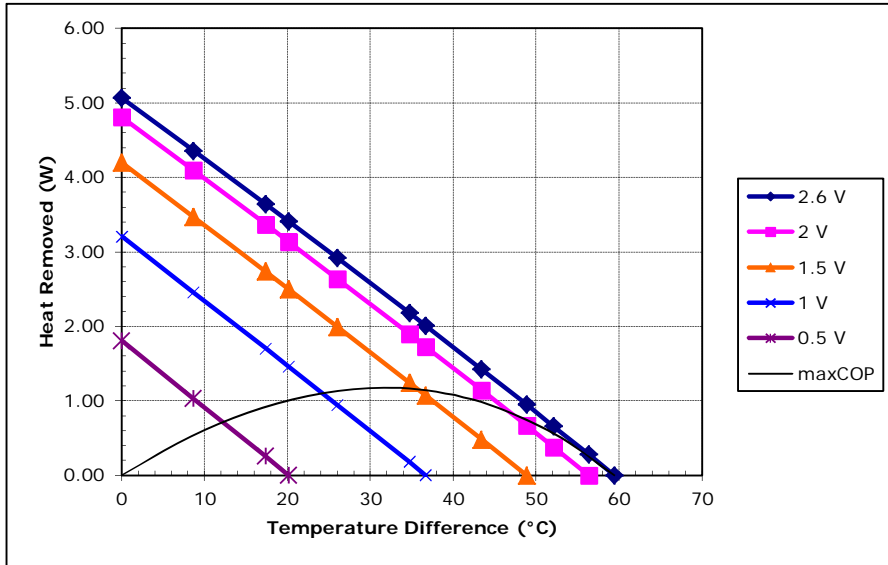

Potted CH-21-1.0-1.3 at a hot-side temperature of 30 °C

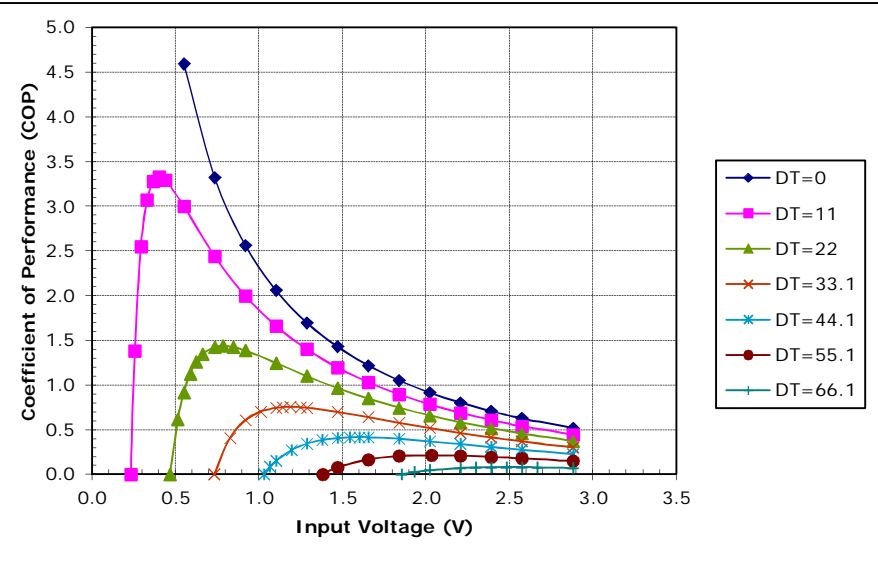
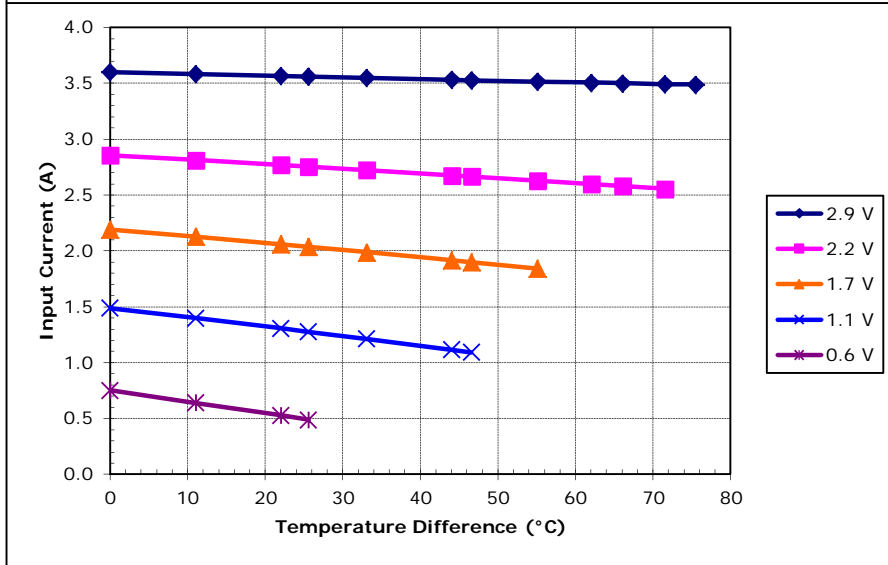
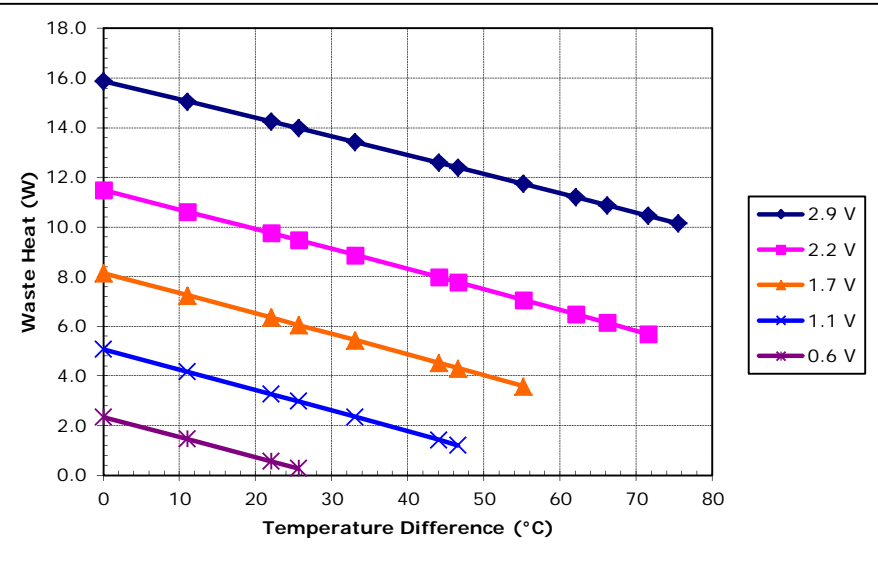
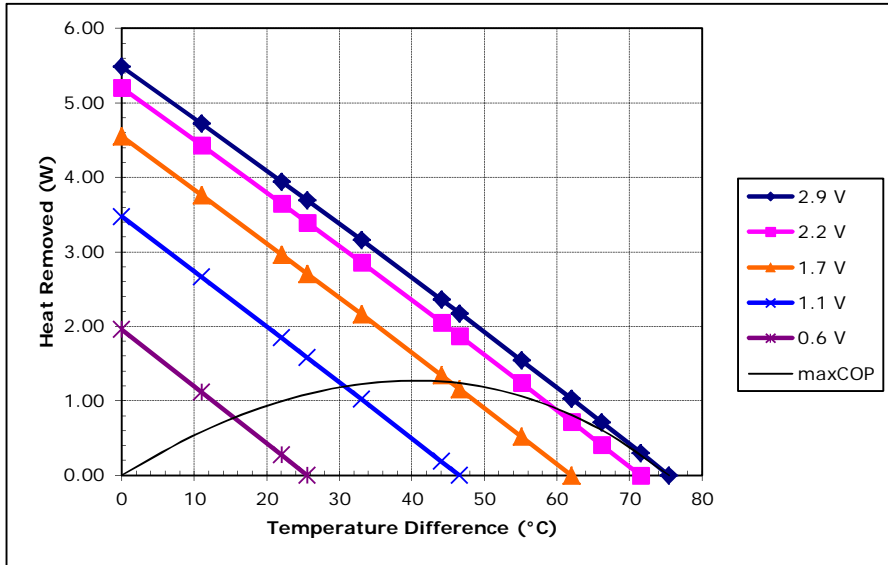

Unpotted CH-21-1.0-1.3 at a hot-side temperature of 50 °C

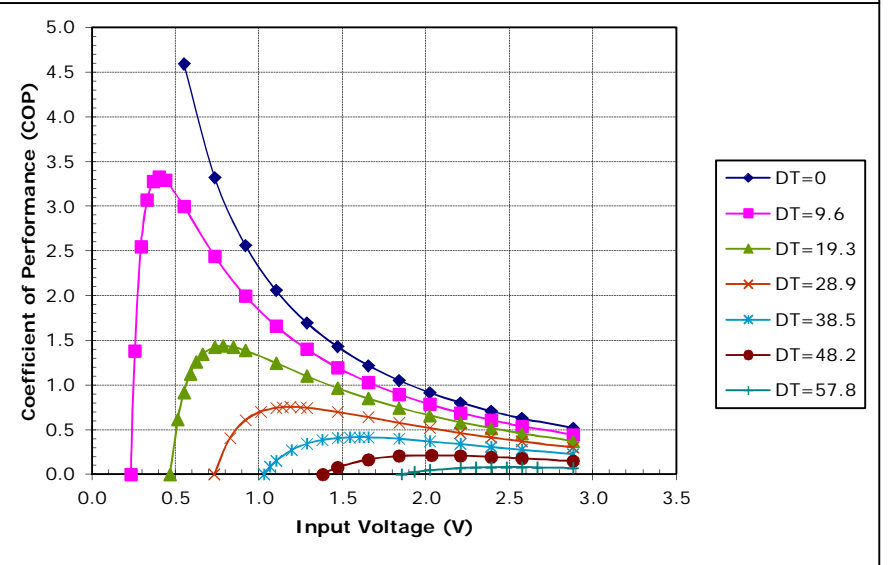
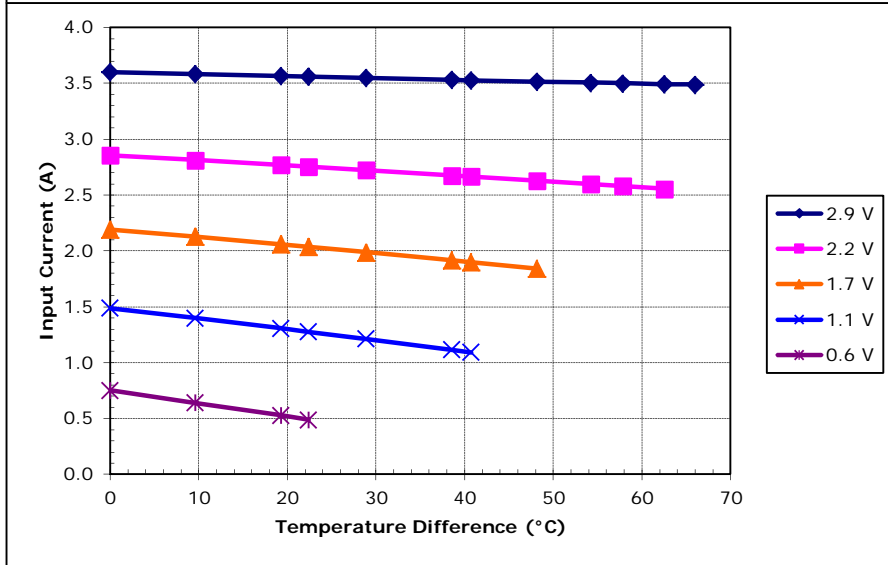
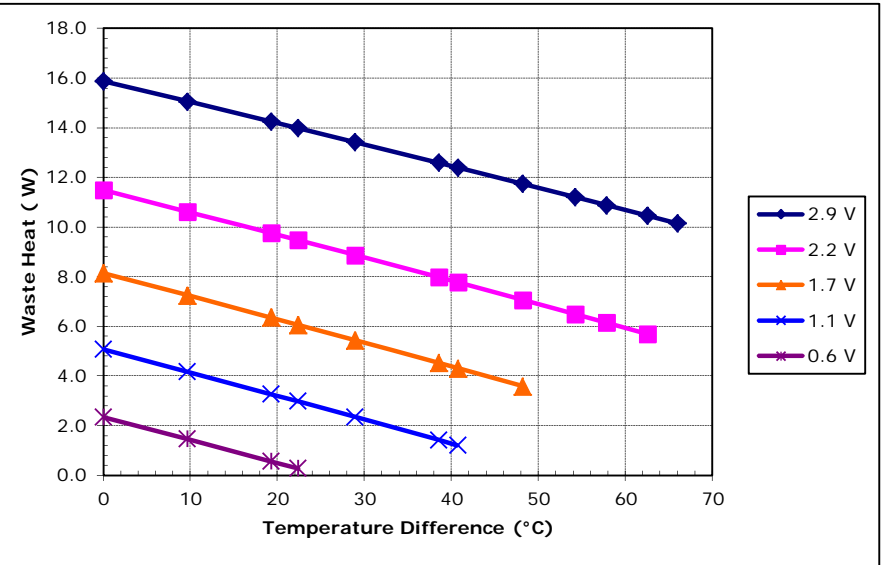
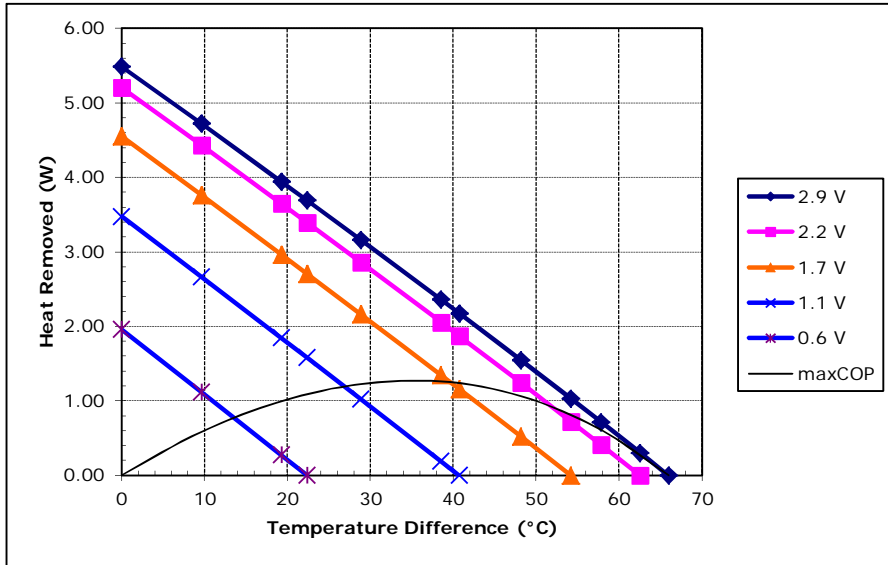

Potted CH-21-1.0-1.3 at a hot-side temperature of 50 °C

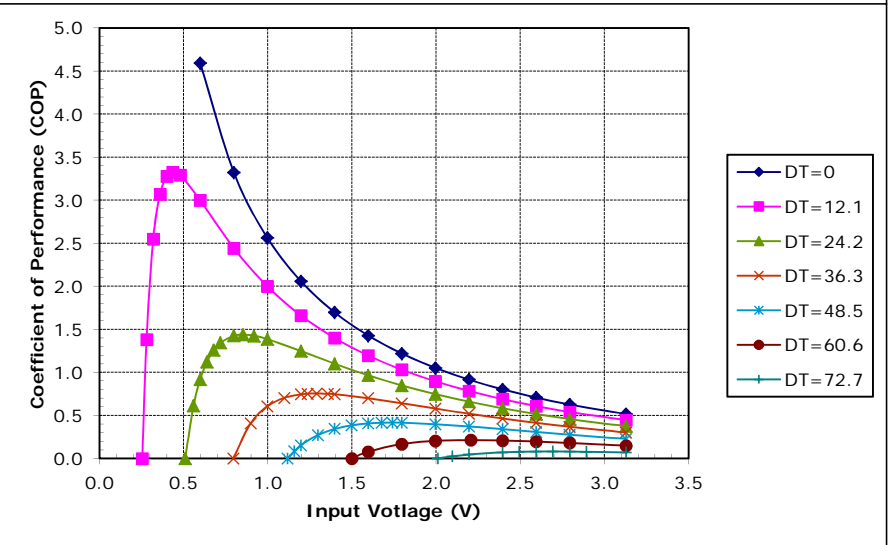
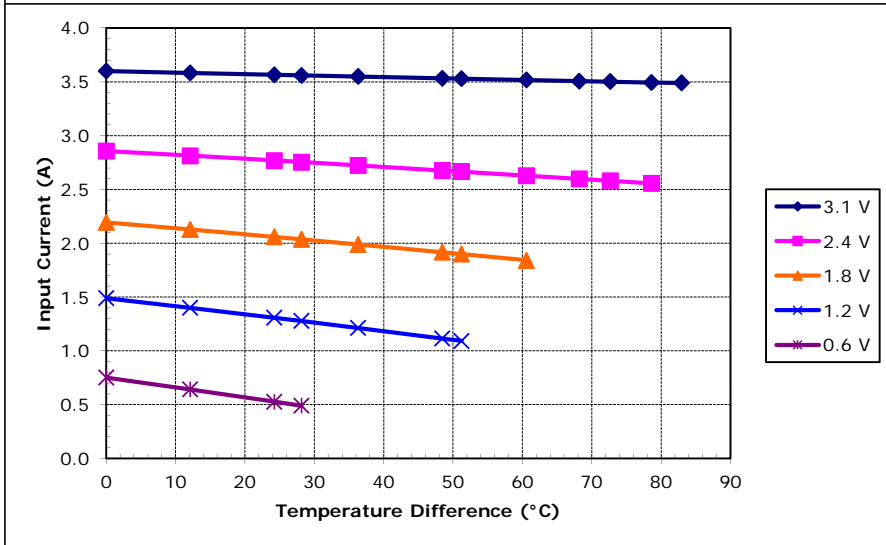
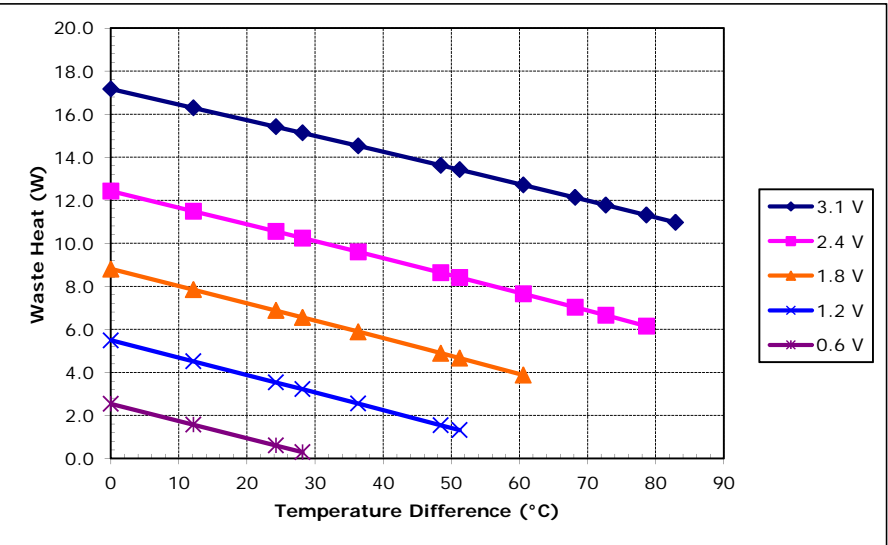
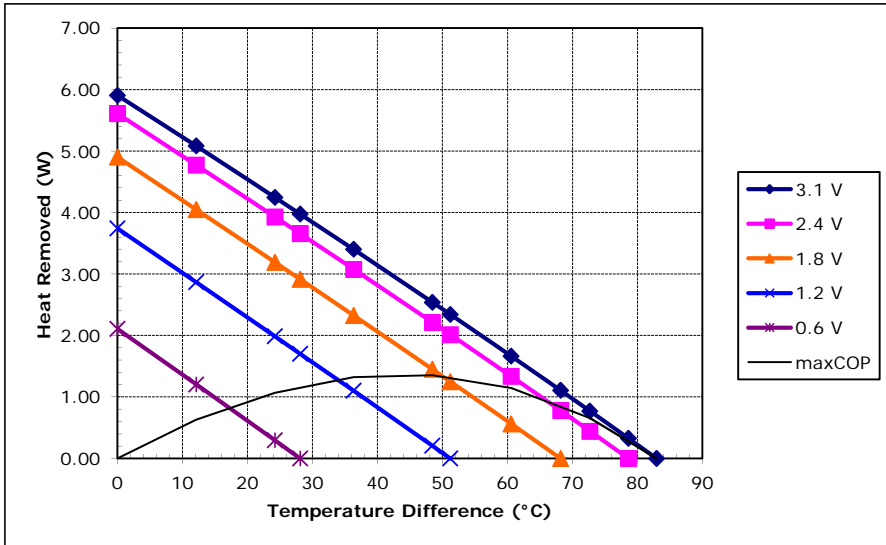

Unpotted CH-21-1.0-1.3 at a hot-side temperature of 70 °C

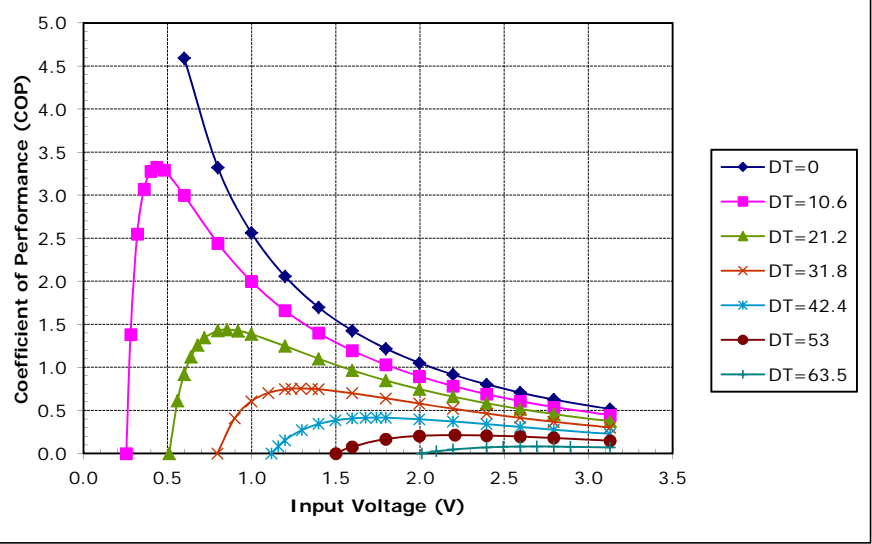
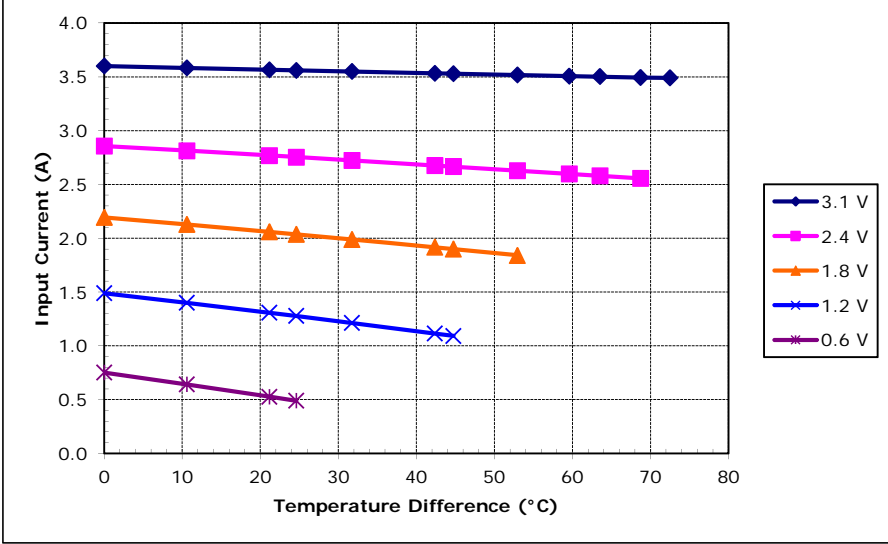
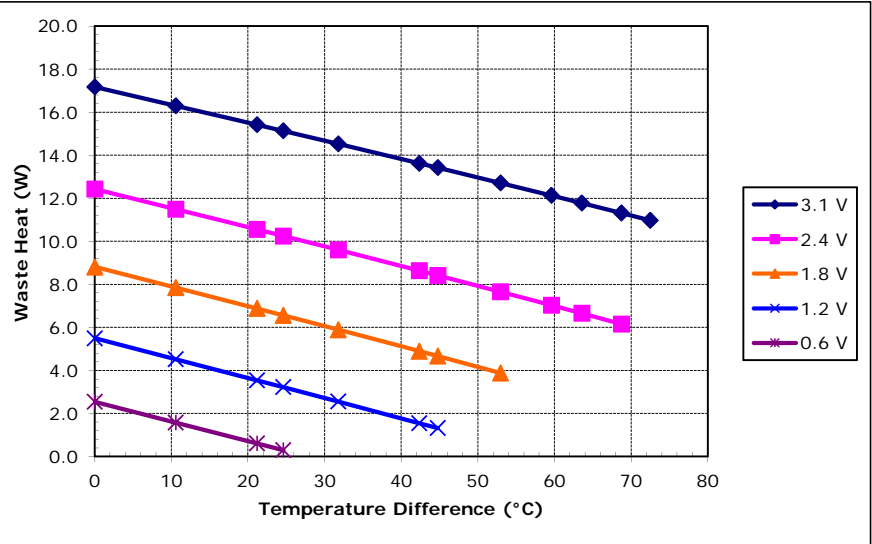
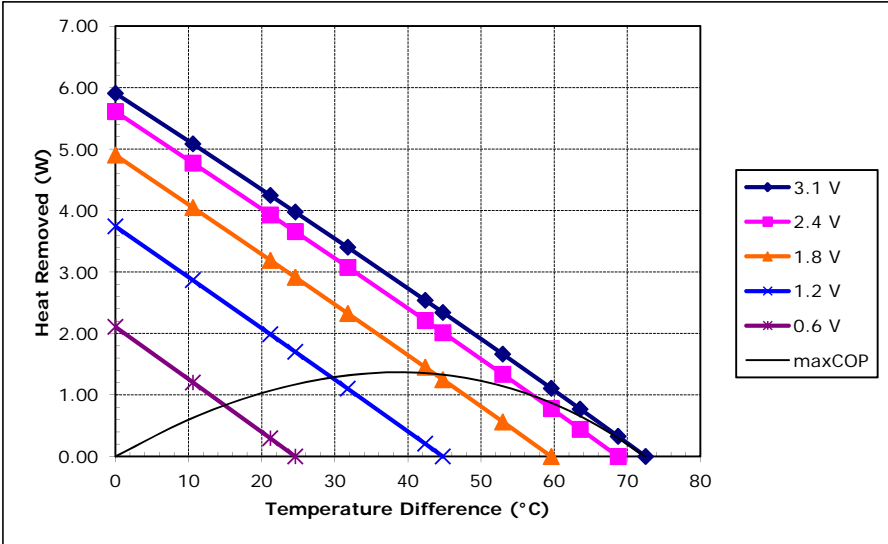

Potted CH-21-1.0-1.3 at a hot-side temperature of 70 °C